

* 1.6mm THICK FR4 (2 LAYER BOARD)

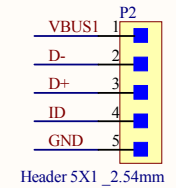
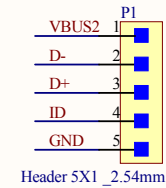
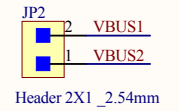
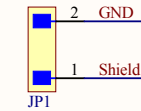
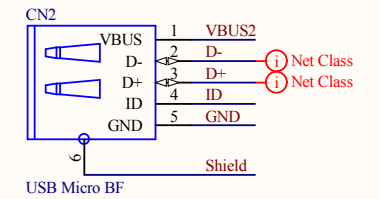
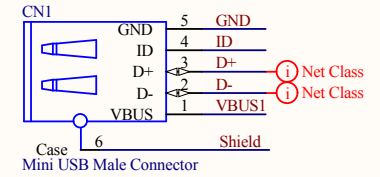
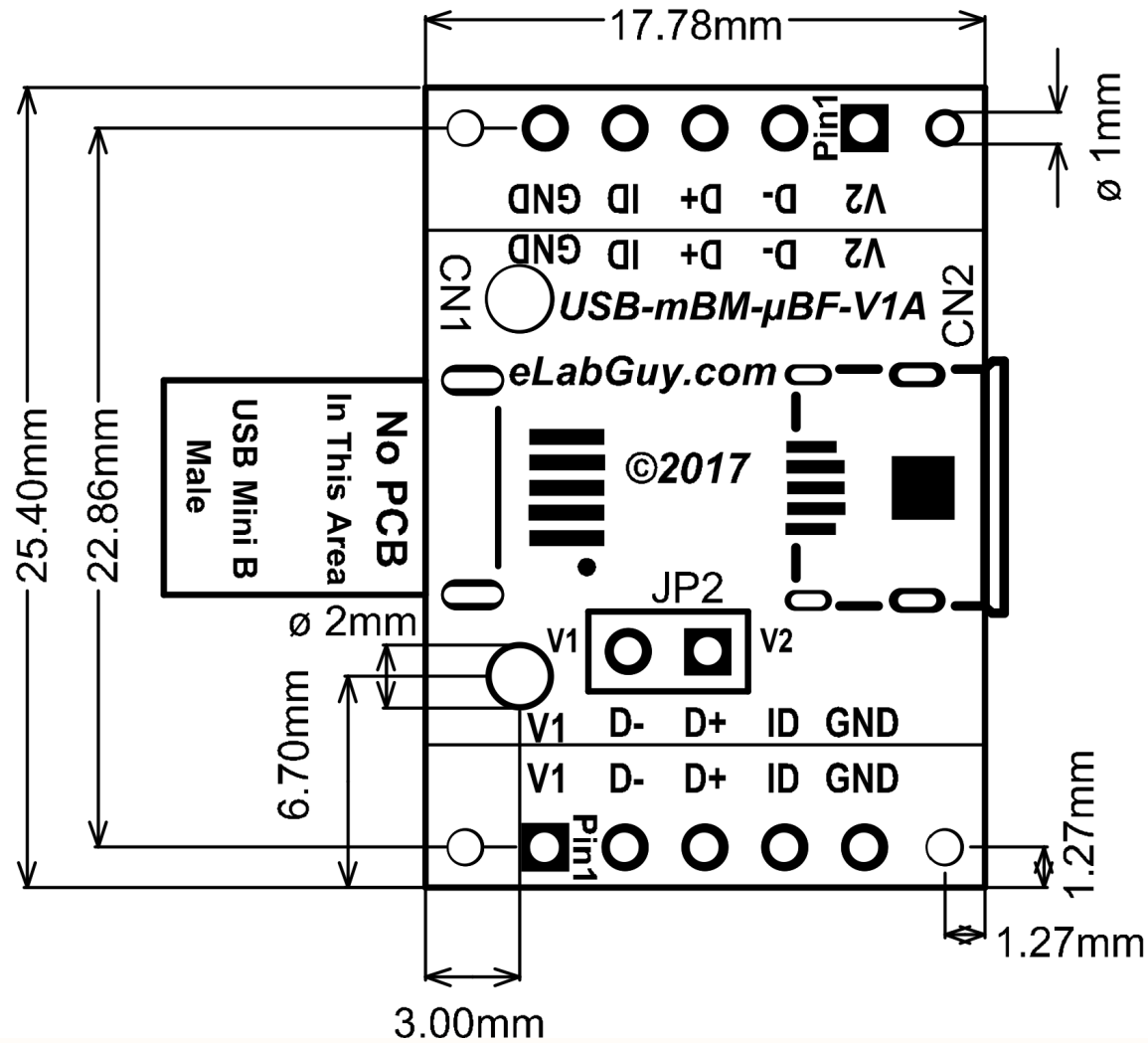

Title			USB2.0 Mini Type B Male to Micro Type B Female Breakout		
Size	Number	Revision			
A4	USB-mBM-μBF-V1A	1A			
Date:	9/6/2017	Sheet of			
File:	C:\Users\...USB-mBM-μBF-V1A Drawing	Drawn By:		www.eLabGuy.com	